

Power Supply

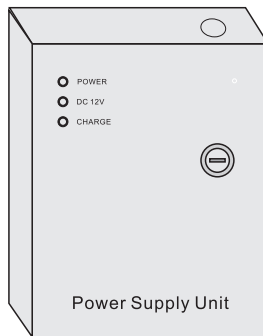

2. Connection

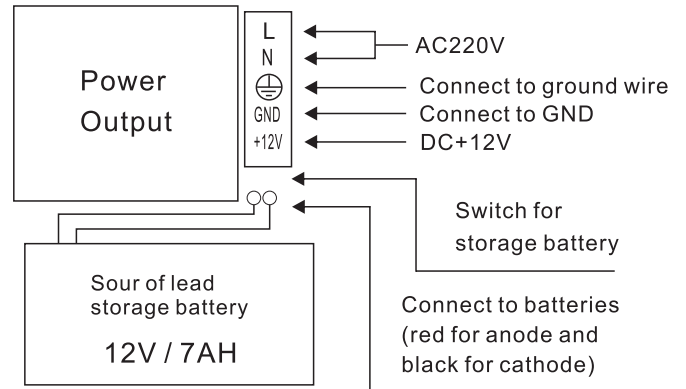

1. Assembly

Bottom

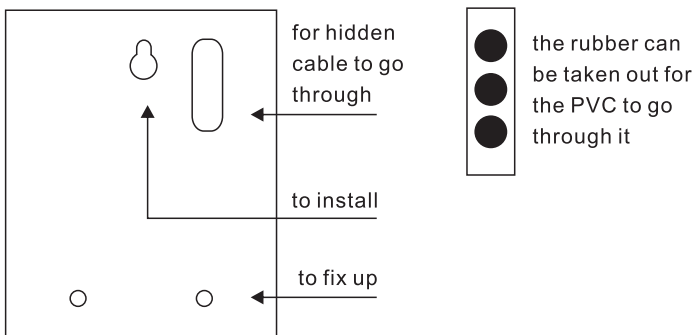

3. Specification

- ◇ Input : AC190-265V 50-60Hz
- ◇ Output : DC12V±15%
- ◇ Output current: Max 5A
- ◇ Storage battery: 12V/7AH

4. Function of protect

- ◇ Output Short protection
- ◇ Output Overcurrent protection
- ◇ Output Overvoltage protection

If the load happen to short-circuit, the power supply would not be output, and it will continue to work automatically when the short-circuit is settled.

* Weight and Size are Only Approximation and May be Modified Without Prior Notification.

